

Thermally-Enhanced High Power RF LDMOS FET 85 W, 2500 – 2700 MHz

Description

The PTFA260851E and PTFA260851F are 85-watt LDMOS FETs designed for WiMAX power amplifier applications in the 2500 to 2700 MHz band. Features include input and output matching, and thermally-enhanced packages with slotted or earless flanges. Manufactured with Infineon's advanced LDMOS process, these devices provide excellent thermal performance and superior reliability.

PTFA260851E
Package H-30248-2

PTFA260851F
Package H-31248-2

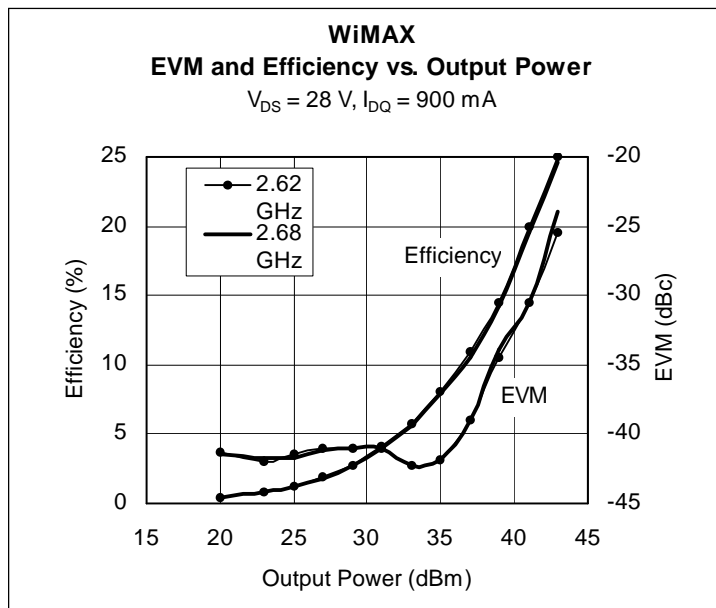
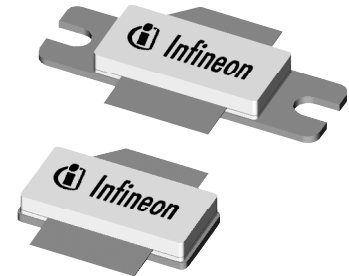

Features

- Thermally-enhanced, Pb-free and RoHS-compliant packages
- Broadband internal matching
- Typical WiMAX performance at 2680 MHz, 28 V
 - Average output power = 16 W
 - Linear Gain = 14 dB
 - Efficiency = 22%
 - Error Vector Magnitude = -29 dB
- Typical CW performance, 2680 MHz, 28 V
 - Output power at P-1dB = 100 W
 - Efficiency = 47%
- Integrated ESD protection: Human Body Model, Class 2 (minimum)
- Excellent thermal stability, low HCI drift
- Capable of handling 10:1 VSWR @ 28 V, 85 W (CW) output power

RF Characteristics

WiMAX Measurements (not subject to production test—verified by design/characterization in Infineon test fixture)

$V_{DD} = 28\text{ V}, I_{DQ} = 900\text{ mA}, P_{OUT} = 16\text{ W}$ average, $f = 2680\text{ MHz}$, modulation = 64 QAM 2/3, channel bandwidth = 3.5 MHz, sample rate = 4 MHz

Characteristic	Symbol	Min	Typ	Max	Unit
Gain	G_{ps}	—	14	—	dB
Drain Efficiency	η_D	—	22	—	%
Error Vector Magnitude	EVM	—	-29	—	dB

All published data at $T_{CASE} = 25^\circ\text{C}$ unless otherwise indicated

ESD: Electrostatic discharge sensitive device—observe handling precautions!

RF Characteristics (cont.)

Two-tone Measurements (tested in Infineon test fixture)

$V_{DD} = 28\text{ V}$, $I_{DQ} = 900\text{ mA}$, $P_{OUT} = 85\text{ W PEP}$, $f = 2680\text{ MHz}$, tone spacing = 1 MHz

Characteristic	Symbol	Min	Typ	Max	Unit
Gain	G_{ps}	13	14	—	dB
Drain Efficiency	η_D	33	36	—	%
Intermodulation Distortion	IMD	—	-30	-28	dBc

DC Characteristics

Characteristic	Conditions	Symbol	Min	Typ	Max	Unit
Drain-Source Breakdown Voltage	$V_{GS} = 0\text{ V}$, $I_{DS} = 10\text{ mA}$	$V_{(BR)DSS}$	65	—	—	V
Drain Leakage Current	$V_{DS} = 28\text{ V}$, $V_{GS} = 0\text{ V}$	I_{DSS}	—	—	1.0	μA
	$V_{DS} = 63\text{ V}$, $V_{GS} = 0\text{ V}$	I_{DSS}	—	—	10.0	μA
On-State Resistance	$V_{GS} = 10\text{ V}$, $V_{DS} = 0.1\text{ V}$	$R_{DS(on)}$	—	0.095	—	Ω
Operating Gate Voltage	$V_{DS} = 28\text{ V}$, $I_{DQ} = 900\text{ mA}$	V_{GS}	2.0	2.5	3.0	V
Gate Leakage Current	$V_{GS} = 10\text{ V}$, $V_{DS} = 0\text{ V}$	I_{GSS}	—	—	1.0	μA

Maximum Ratings

Parameter	Symbol	Value	Unit
Drain-Source Voltage	V_{DSS}	65	V
Gate-Source Voltage	V_{GS}	-0.5 to +12	V
Junction Temperature	T_J	200	$^{\circ}\text{C}$
Total Device Dissipation	P_D	437.5	W
		Above 25 $^{\circ}\text{C}$ derate by	2.5
Storage Temperature Range	T_{STG}	-40 to +150	$^{\circ}\text{C}$
Thermal Resistance ($T_{CASE} = 70^{\circ}\text{C}$, 85 W CW)	$R_{\theta JC}$	0.4	$^{\circ}\text{C}/\text{W}$

Ordering Information

Type and Version	Package Type	Package Description	Marking
PTFA260851E V1	H-30248-2	Thermally-enhanced slotted flange, single-ended	PTFA260851E
PTFA260851F V1	H-31248-2	Thermally-enhanced earless flange, single-ended	PTFA260851F

Typical Performance (data taken in a production test fixture)

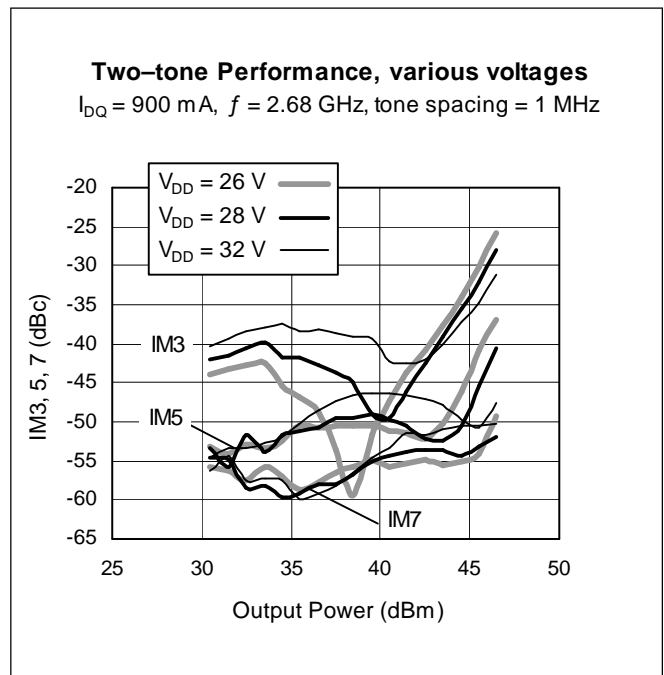
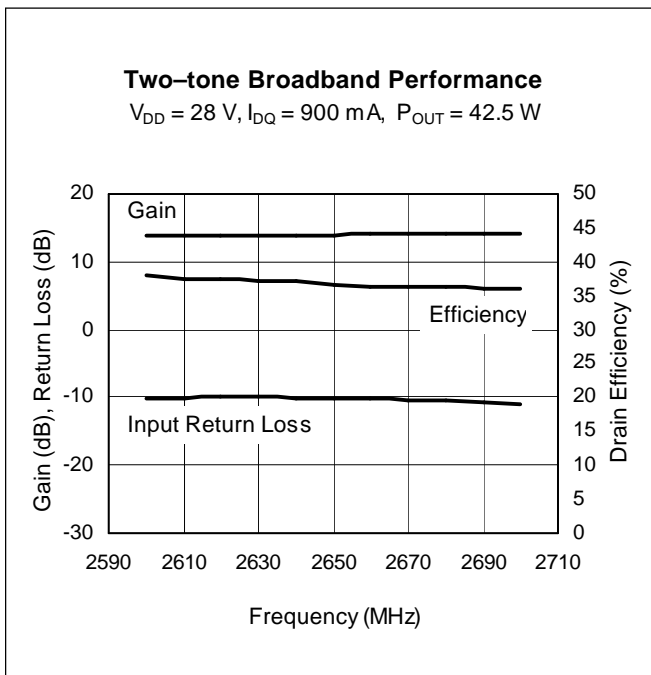
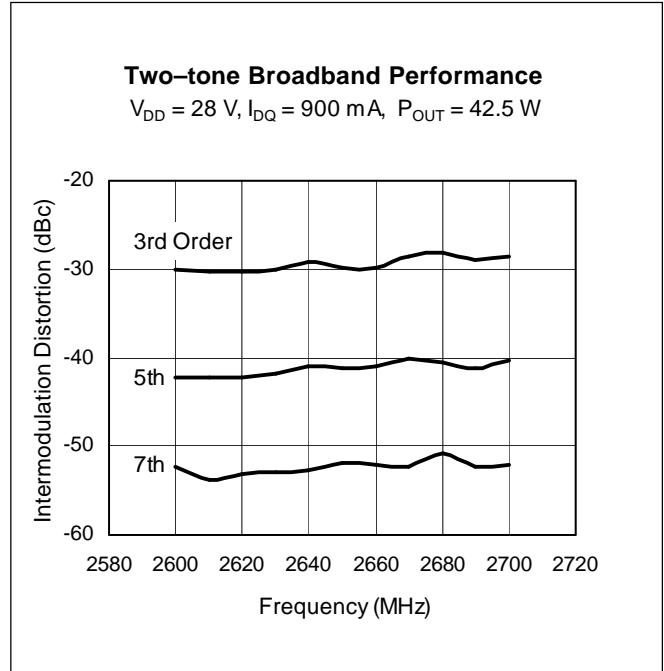
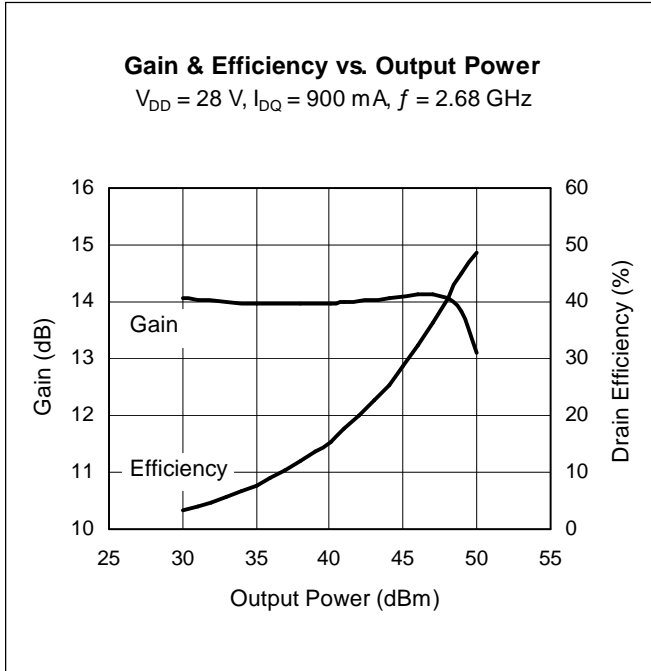

Typical Performance (cont.)

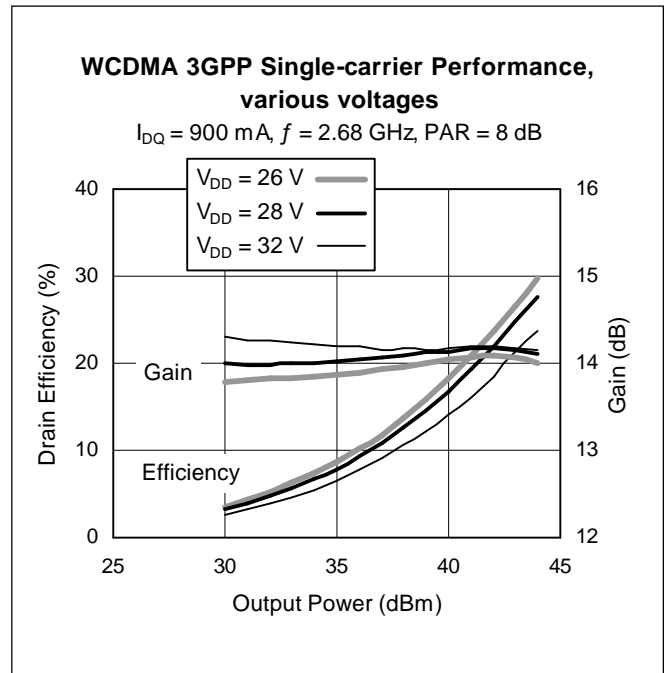
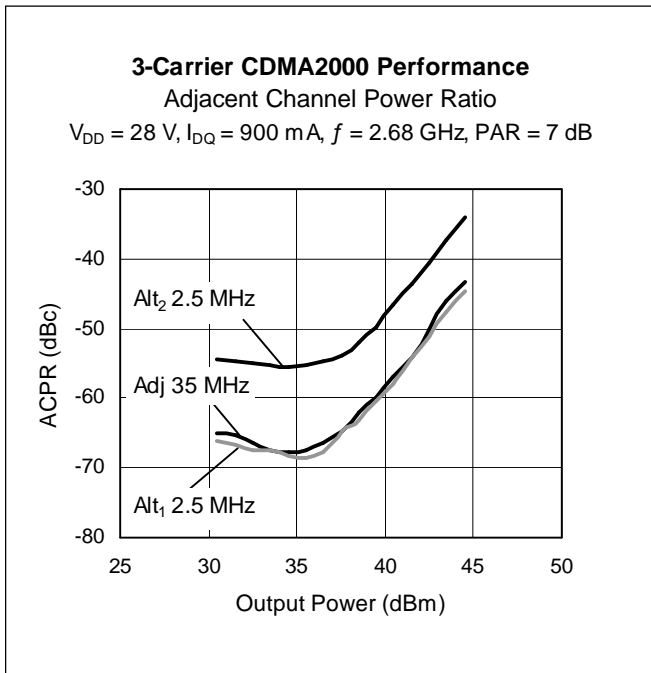
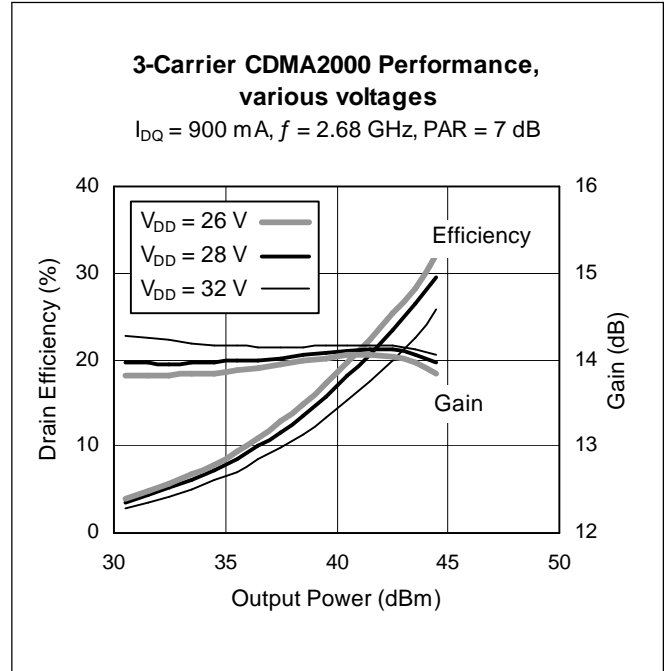
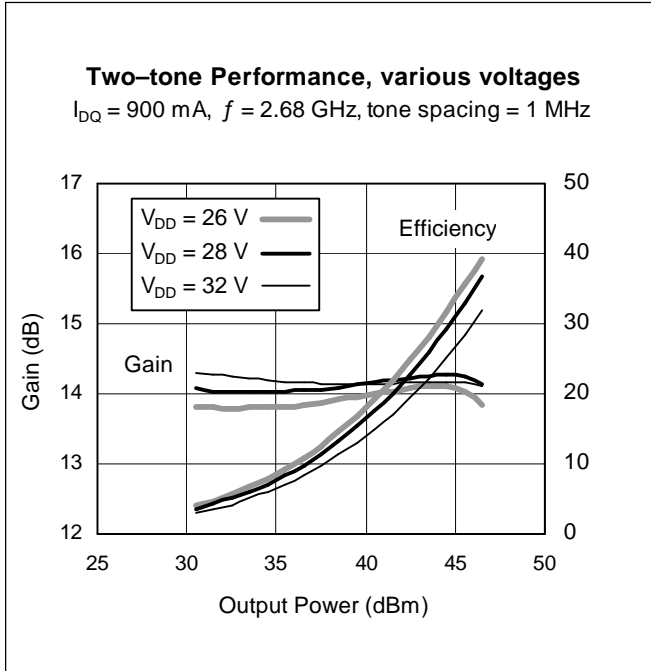

Typical Performance (cont.)

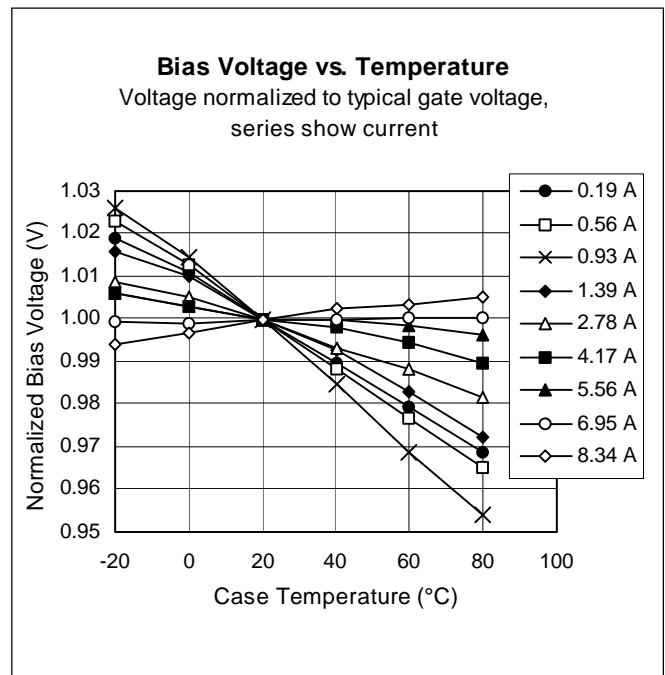
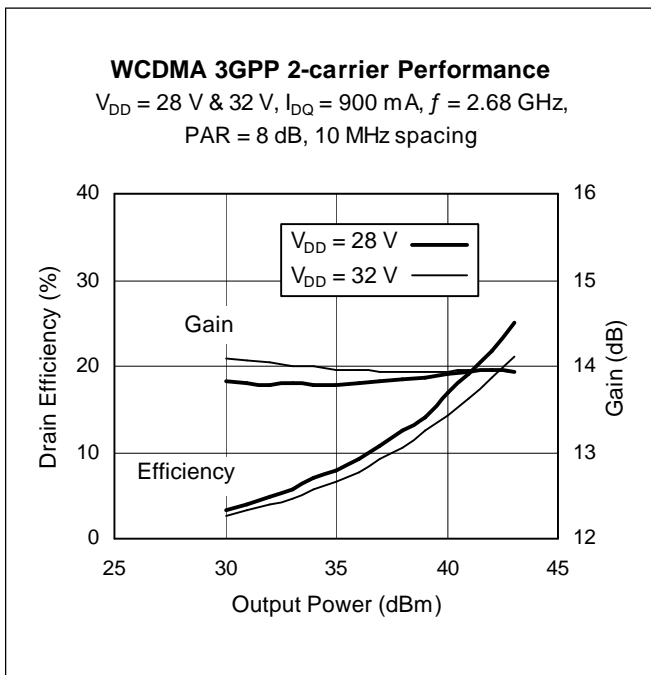
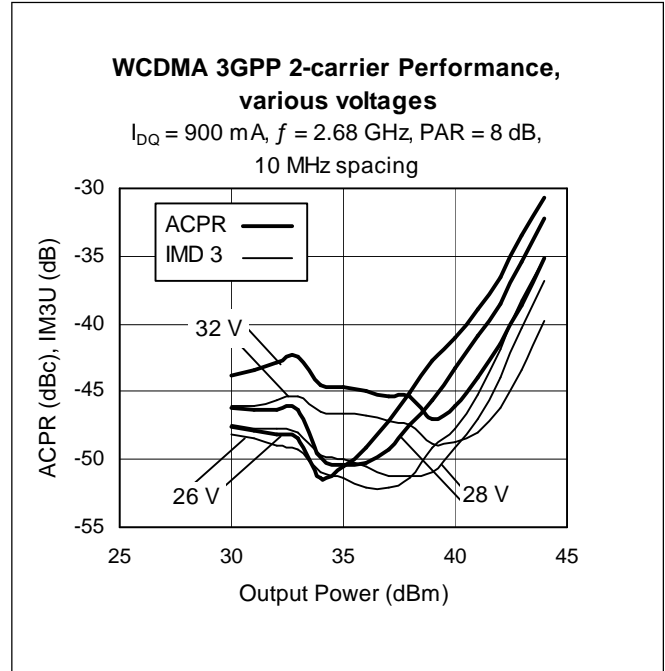
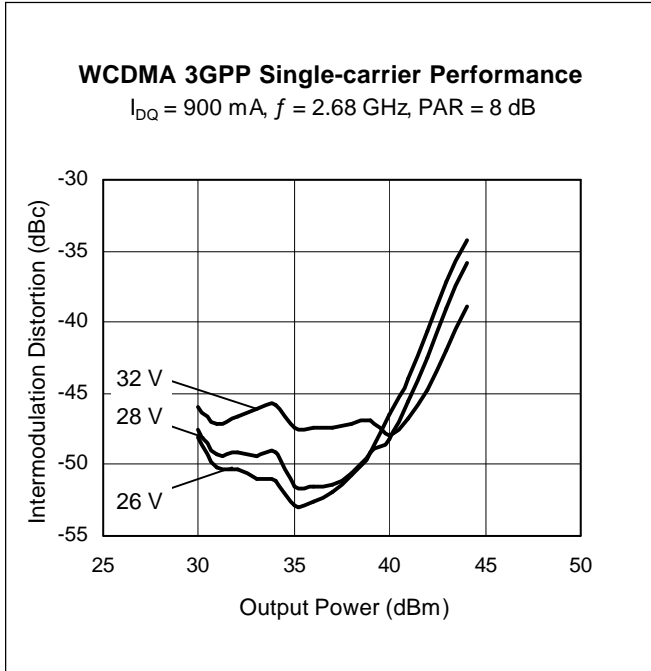

Broadband Circuit Impedance

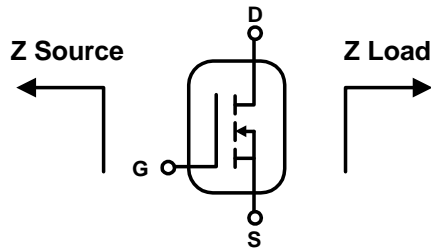

Frequency MHz	Z Source W		Z Load W	
	R	jX	R	jX
2600	4.4	3.8	1.8	2.5
2620	4.4	3.9	1.8	2.7
2650	4.3	4.2	1.7	2.9
2680	4.2	4.5	1.7	3.2
2700	4.2	4.7	1.6	3.3

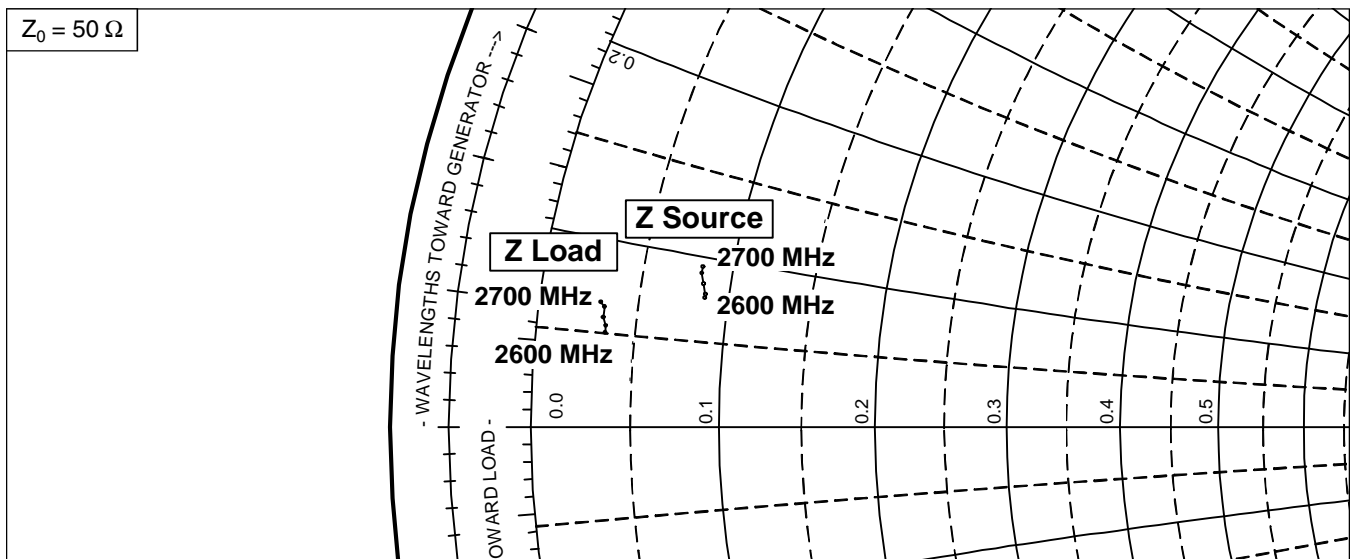

See next page for circuit information

Reference Circuit

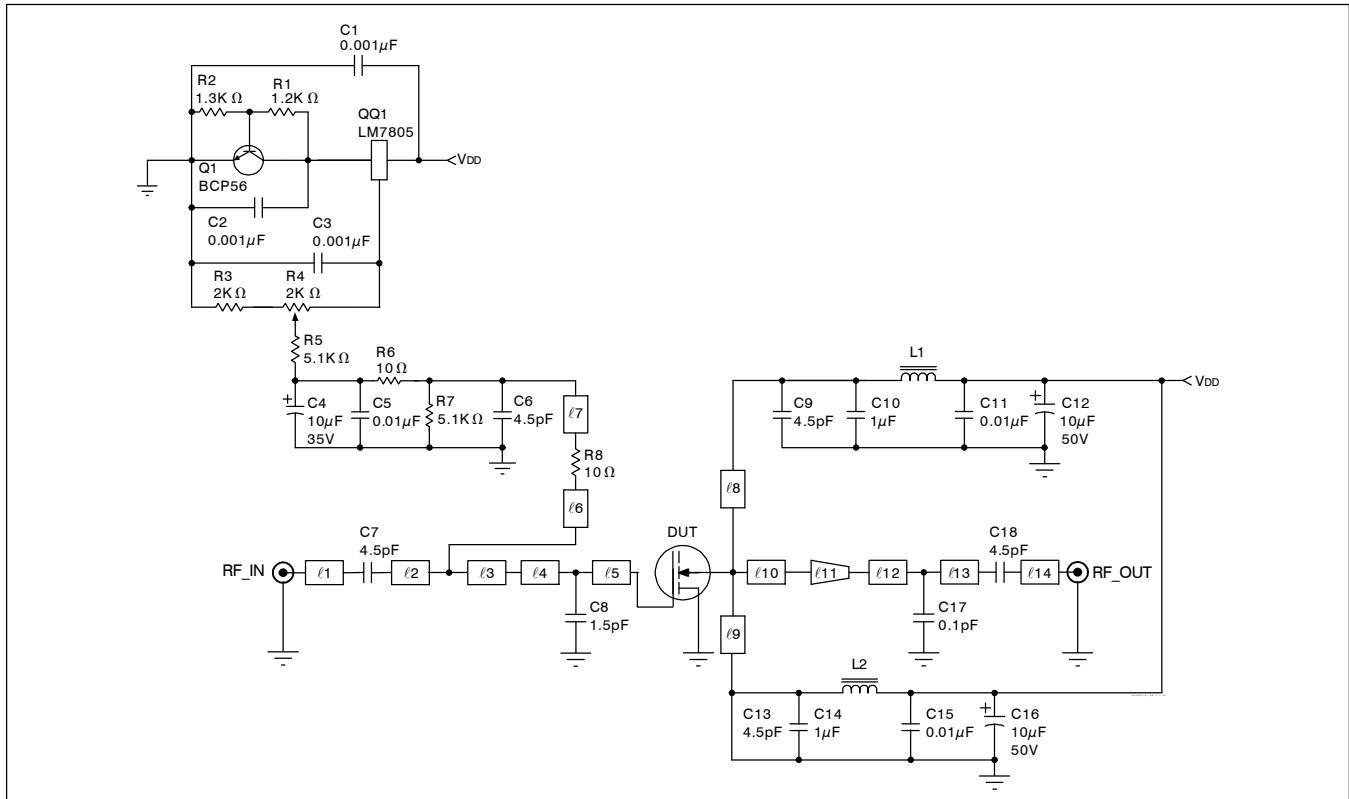

Reference circuit schematic for $f = 2650$ MHz

Circuit Assembly Information

DUT	PTFA260851E or PTFA260851F	LDMOS Transistor	
PCB	0.76 mm [0.030"] thick, $\epsilon_r = 4.5$	TMM4	2 oz. copper

Microstrip	Electrical Characteristics at 2650 MHz	Dimensions: L x W (mm)	Dimensions: L x W (in.)
l_1	0.121λ , 46.9 Ω	7.42 x 1.52	0.292 x 0.060
l_2	0.135λ , 40.5 Ω	8.20 x 1.93	0.323 x 0.076
l_3	0.021λ , 40.5 Ω	1.27 x 1.93	0.050 x 0.076
l_4	0.028λ , 14.7 Ω	1.60 x 7.54	0.063 x 0.297
l_5	0.079λ , 8.3 Ω	4.37 x 14.66	0.172 x 0.577
l_6	0.008λ , 57.9 Ω	0.51 x 1.04	0.020 x 0.041
l_7	0.272λ , 57.9 Ω	16.79 x 1.04	0.661 x 0.041
l_8	0.278λ , 49.3 Ω	16.89 x 1.40	0.665 x 0.055
l_9	0.278λ , 49.3 Ω	16.89 x 1.40	0.665 x 0.055
l_{10}	0.060λ , 5.2 Ω	3.28 x 24.36	0.129 x 0.959
l_{11} (taper)	0.113λ , 5.2 Ω / 49.3 Ω	6.73 x 24.36 / 1.40	0.265 x 0.959 / 0.055
l_{12}	0.048λ , 49.3 Ω	2.97 x 1.40	0.117 x 0.055
l_{13}	0.095λ , 49.3 Ω	5.84 x 1.40	0.230 x 0.055
l_{14}	0.070λ , 49.3 Ω	4.29 x 1.40	0.169 x 0.055

Reference Circuit (cont.)

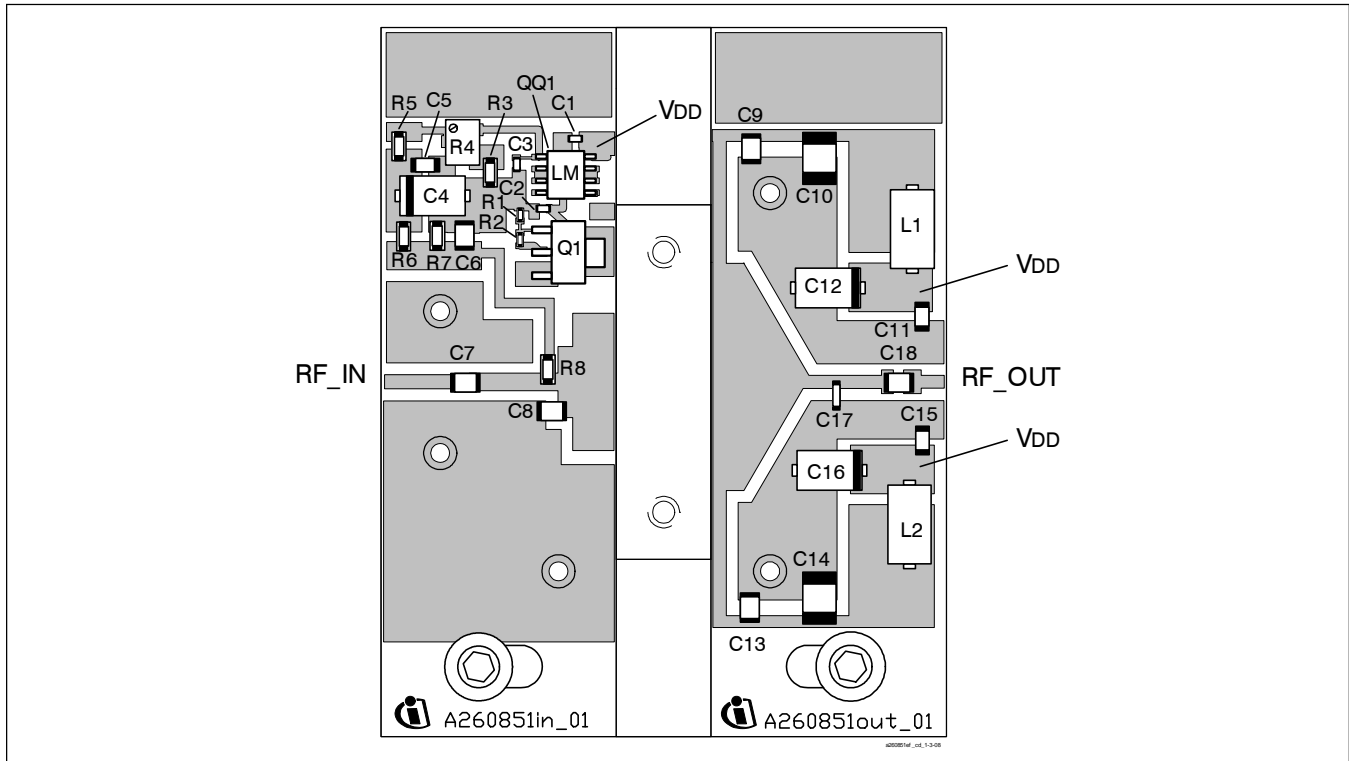

Reference circuit assembly diagram (not to scale)*

Component	Description	Suggested Manufacturer	P/N or Comment
C1, C2, C3	Capacitor, 0.001 μ F	Digi-Key	PCC1772CT-ND
C4	Tantalum capacitor, 10 μ F, 35 V	Digi-Key	399-1655-2-ND
C5, C11, C15	Capacitor, 0.01 μ F	ATC	200B 103
C6, C7, C9, C13, C18	Ceramic capacitor, 4.5 pF	ATC	100B 4R5
C8	Ceramic capacitor, 1.5 pF	ATC	100B 1R5
C10, C14	Capacitor, 1 μ F	ATC	920C105
C12, C16	Tantalum capacitor, 10 μ F, 50 V	Garrett Electronics	TPSE106K050R0400
C17	Ceramic capacitor, 0.1 pF	ATC	100A 0R1
L1, L2	Ferrite, 8.9 mm	Elna Magnetics	BDS 4.6/3/8.9-4S2
Q1	Transistor	Infinition Technologies	BCP56
QQ1	Voltage regulator	National Semiconductor	LM7805
R1	Chip resistor 1.2 k-ohms	Digi-Key	P1.2KGCT-ND
R2	Chip resistor 1.3 k-ohms	Digi-Key	P1.3KGCT-ND
R3	Chip resistor 2 k-ohms	Digi-Key	P2KECT-ND
R4	Potentiometer 2 k-ohms	Digi-Key	3224W-202ETR-ND
R5, R7	Chip resistor 5.1 k-ohms	Digi-Key	P5.1KECT-ND
R6, R8	Chip resistor 10 ohms	Digi-Key	P10ECT-ND

*Gerber Files for this circuit available on request

Package Outline Specifications

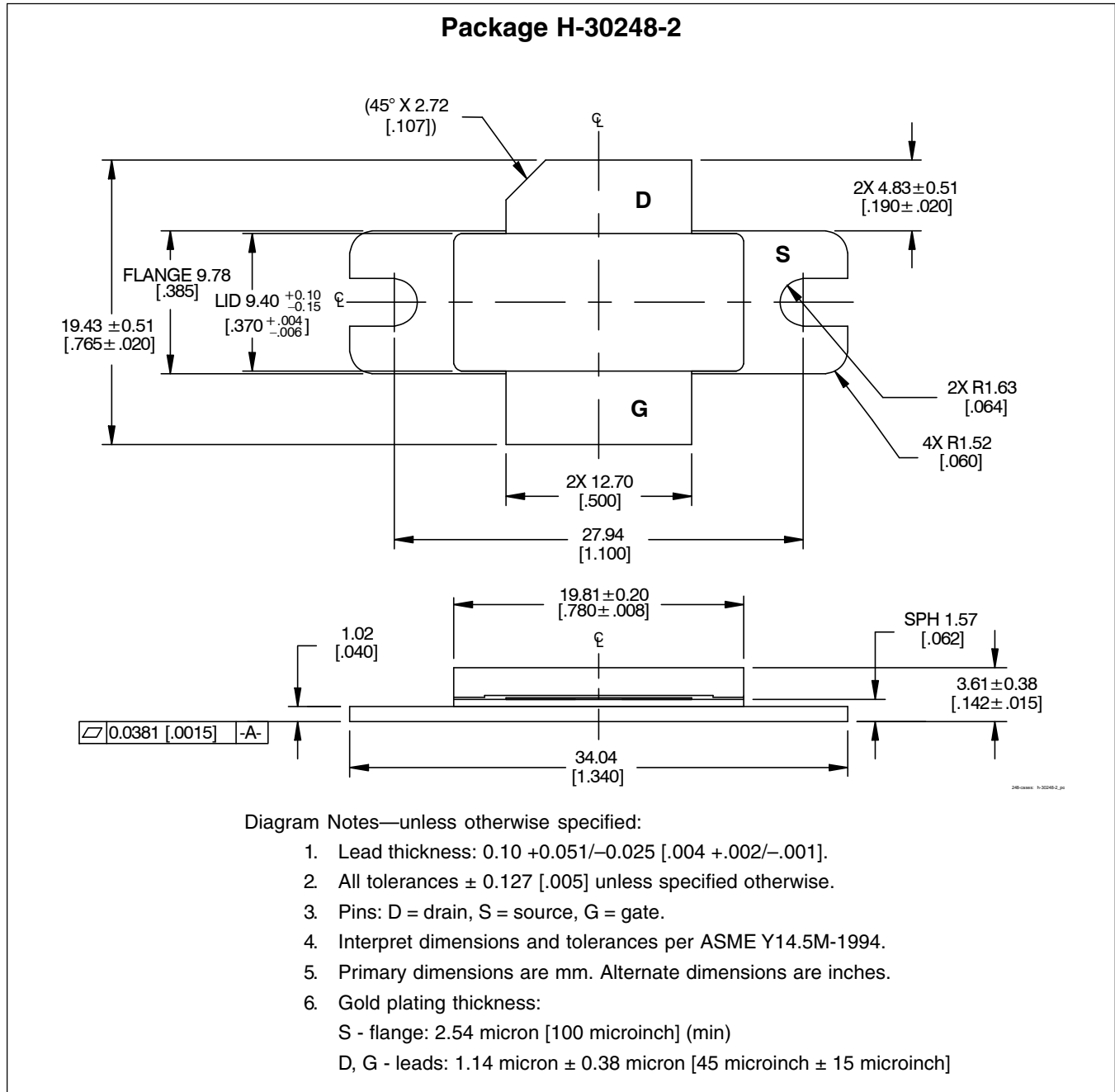

Find the latest and most complete information about products and packaging at the Infineon Internet page
<http://www.infineon.com/products>

Package Outline Specifications

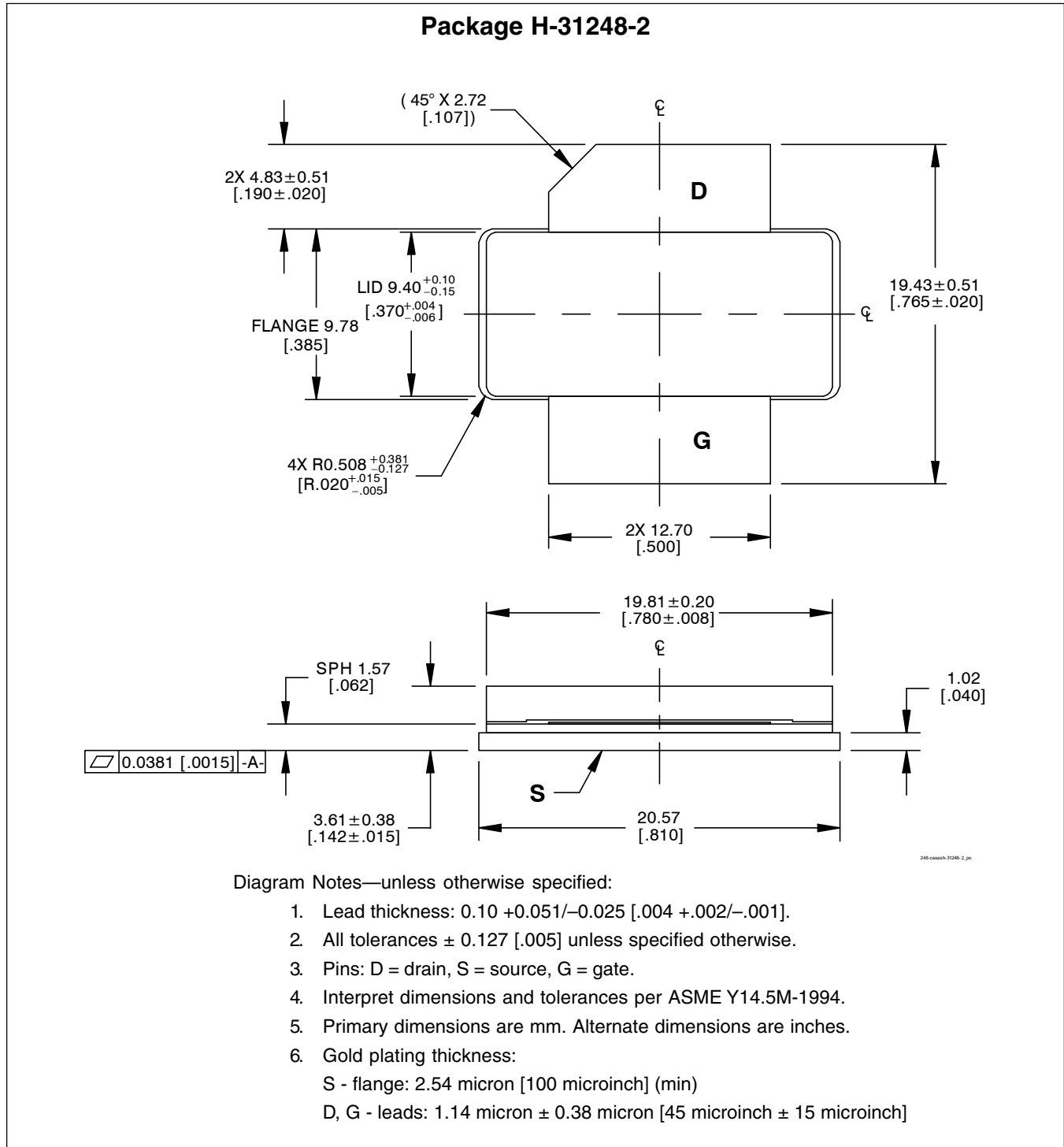

Find the latest and most complete information about products and packaging at the Infineon Internet page
<http://www.infineon.com/products>

Revision History: 2008-02-01

Data Sheet

Previous Version: 2006-07-21, Preliminary Data Sheet

Page	Subjects (major changes since last revision)
6, 7	Add impedance and circuit information.
1	Increase bandwidth from 2620 – 2680 to 2500 – 2700.

We Listen to Your Comments

Any information within this document that you feel is wrong, unclear or missing at all?

Your feedback will help us to continuously improve the quality of this document.

Please send your proposal (including a reference to this document) to:

highpowerRF@infineon.com

To request other information, contact us at:
 +1 877 465 3667 (1-877-GO-LDMOS) USA
 or +1 408 776 0600 International

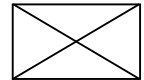

GOLDMOS[®] is a registered trademark of Infineon Technologies AG.

Edition 2008-02-01

Published by

Infineon Technologies AG
81726 München, Germany

© Infineon Technologies AG 2006.

All Rights Reserved.

Legal Disclaimer

The information given in this document shall in no event be regarded as a guarantee of conditions or characteristics ("Beschaffheitsgarantie"). With respect to any examples or hints given herein, any typical values stated herein and/or any information regarding the application of the device, Infineon Technologies hereby disclaims any and all warranties and liabilities of any kind, including without limitation warranties of non-infringement of intellectual property rights of any third party.

Information

For further information on technology, delivery terms and conditions and prices please contact your nearest Infineon Technologies Office (www.infineon.com/rfpower).

Warnings

Due to technical requirements components may contain dangerous substances. For information on the types in question please contact your nearest Infineon Technologies Office.

Infineon Technologies Components may only be used in life-support devices or systems with the express written approval of Infineon Technologies, if a failure of such components can reasonably be expected to cause the failure of that life-support device or system, or to affect the safety or effectiveness of that device or system. Life support devices or systems are intended to be implanted in the human body, or to support and/or maintain and sustain and/or protect human life. If they fail, it is reasonable to assume that the health of the user or other persons may be endangered.